

NORLEG	
Klatresystem Brokk	
Z12711	
Dato 22.06.2017	REV. -

< 2500

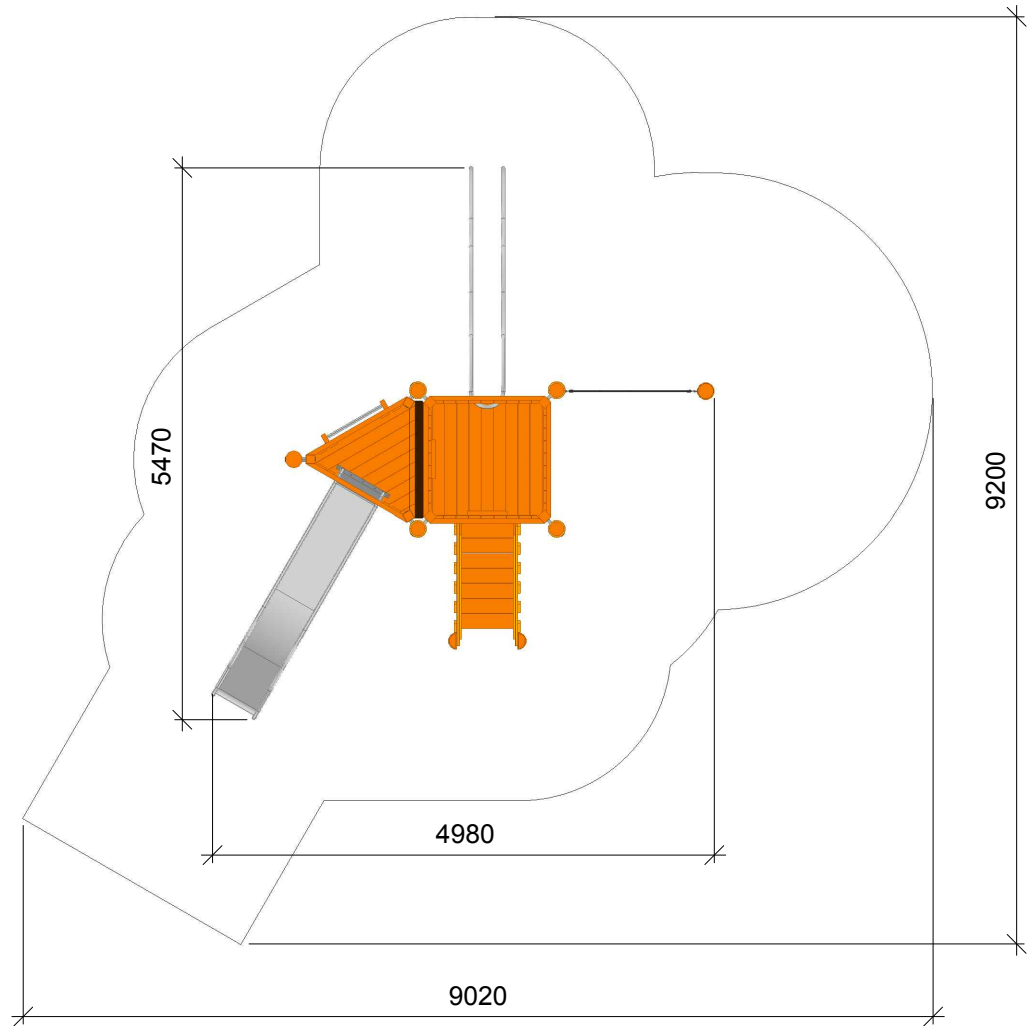

≥ EN 1176

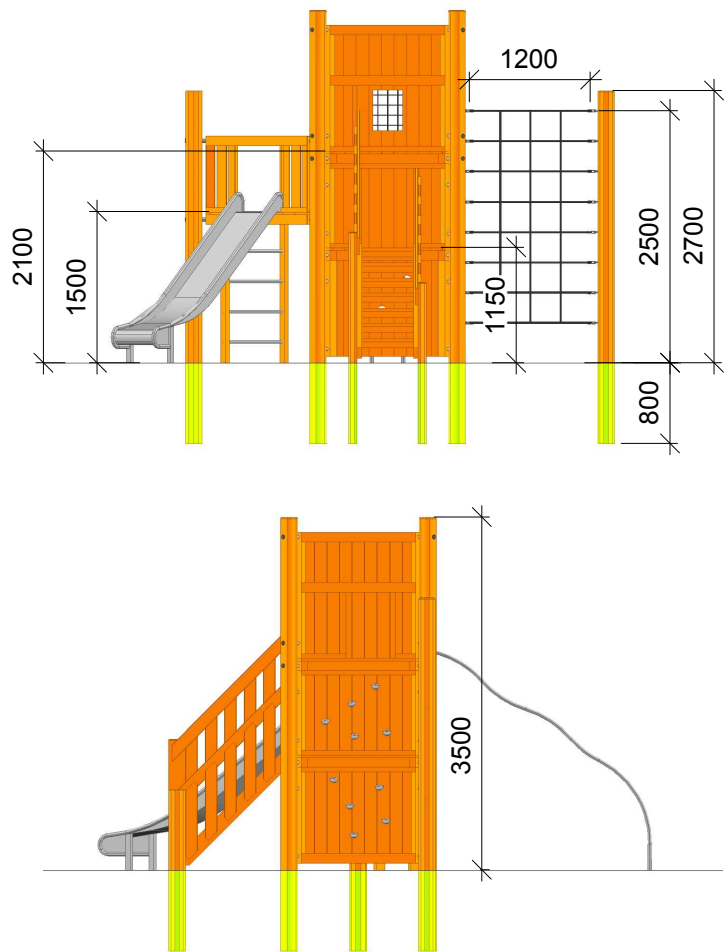

This drawing is the property of NORLEG and pursuant to current legislation may not be copied, transferred to or used by any third party. Should this drawing be used, a fee of 10% of the assumed contract price will be charged.

1:75

NORLEG	
Klatresystem Brokk	
Z12711	
Dato 22.06.2017	REV. -



This drawing is the property of NORLEG and pursuant to current legislation may not be copied, transferred to or used by any third party. Should this drawing be used, a fee of 10% of the assumed contract price will be charged.

NORLEG	
Klatresystem Brokk	
Z12711	
Dato 22.06.2017	REV. -

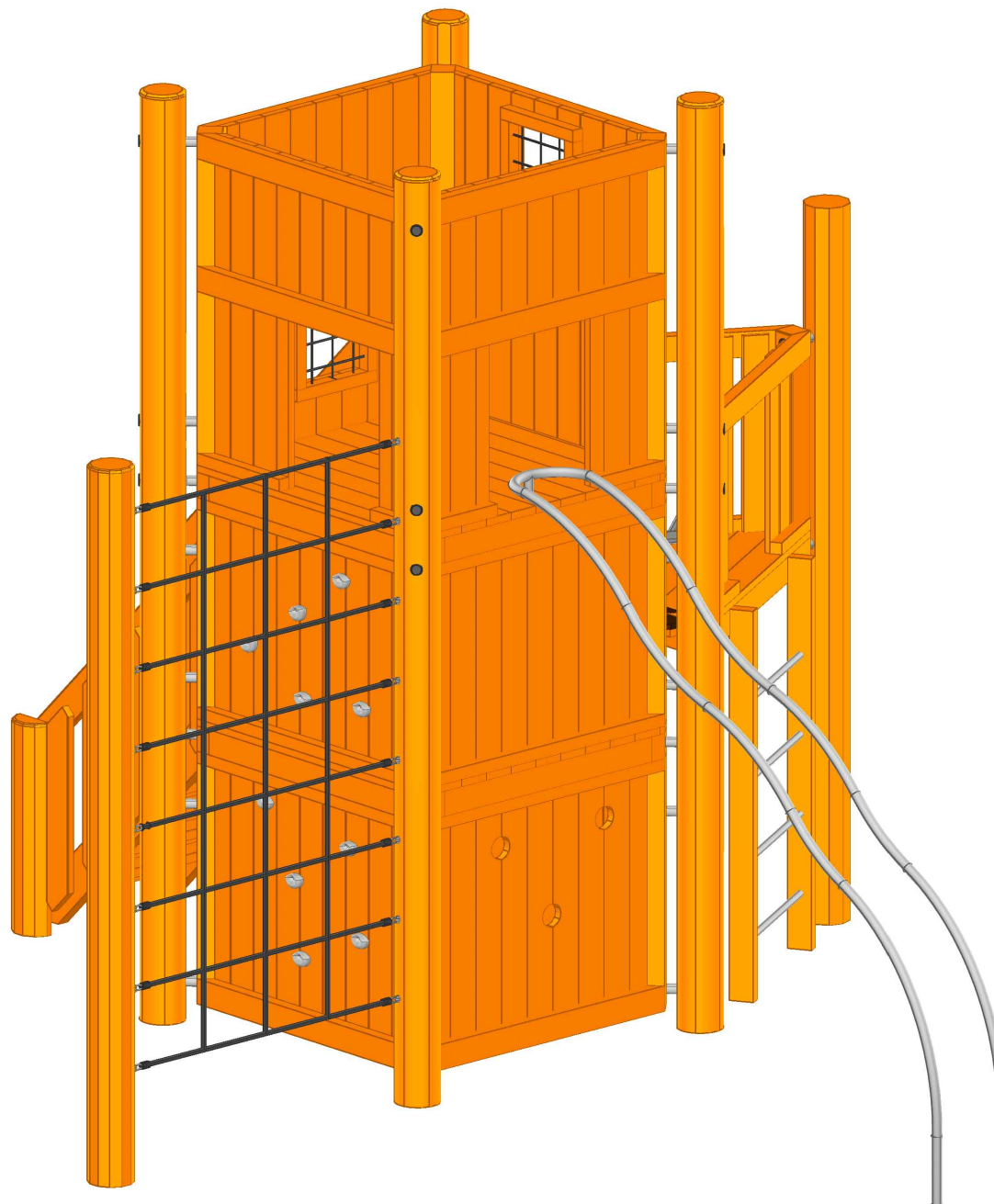

This drawing is the property of NORLEG and pursuant to current legislation may not be copied, transferred to or used by any third party. Should this drawing be used, a fee of 10% of the assumed contract price will be charged.

NORLEG	
Klatresystem Brokk	
Z12711	
Dato 22.06.2017	REV. -

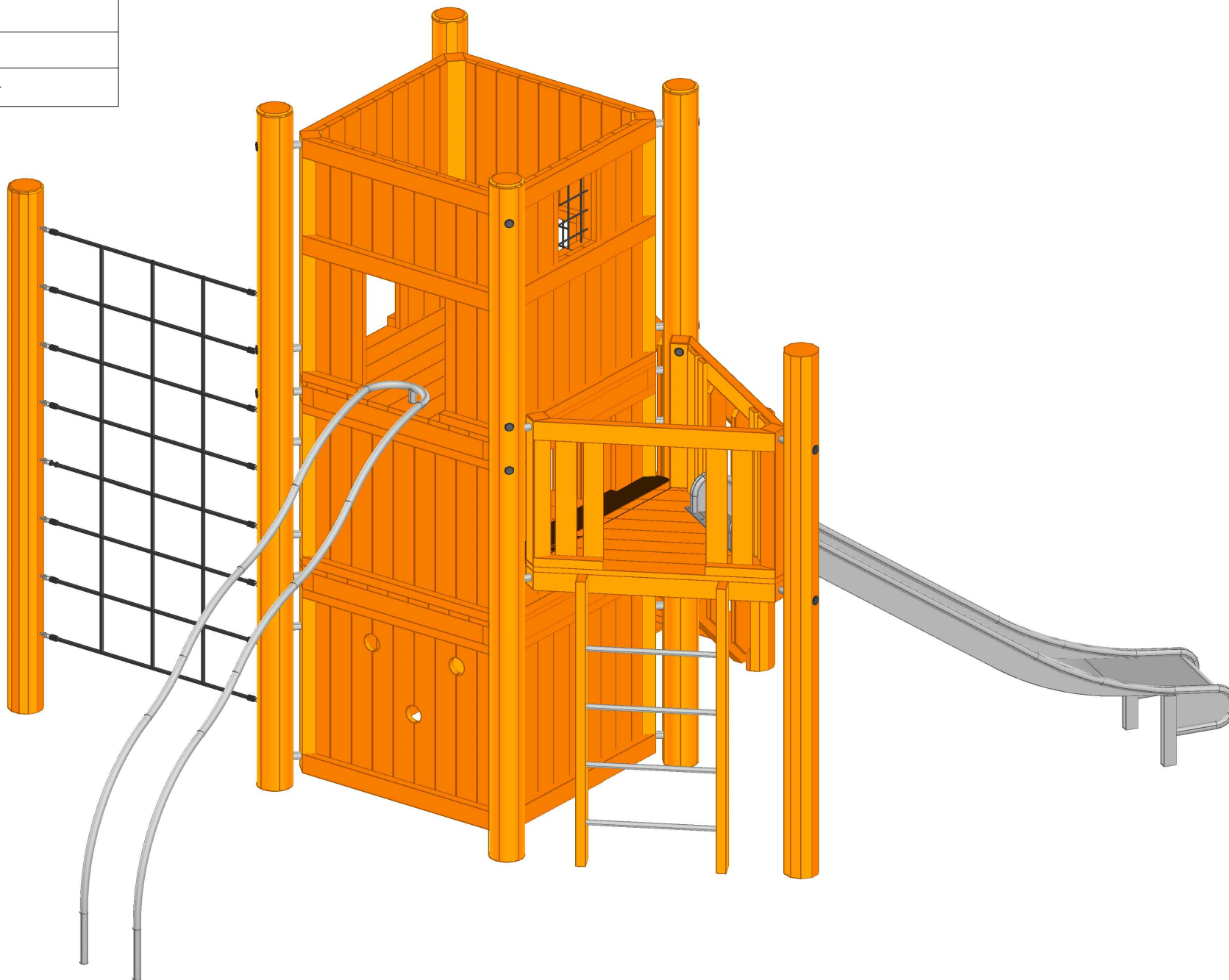

This drawing is the property of NORLEG and pursuant to current legislation may not be copied, transferred to or used by any third party. Should this drawing be used, a fee of 10% of the assumed contract price will be charged.

NORLEG	
Klatresystem Brokk	
Z12711	
Dato 22.06.2017	REV. -

< 2500

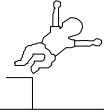

≥ EN 1176

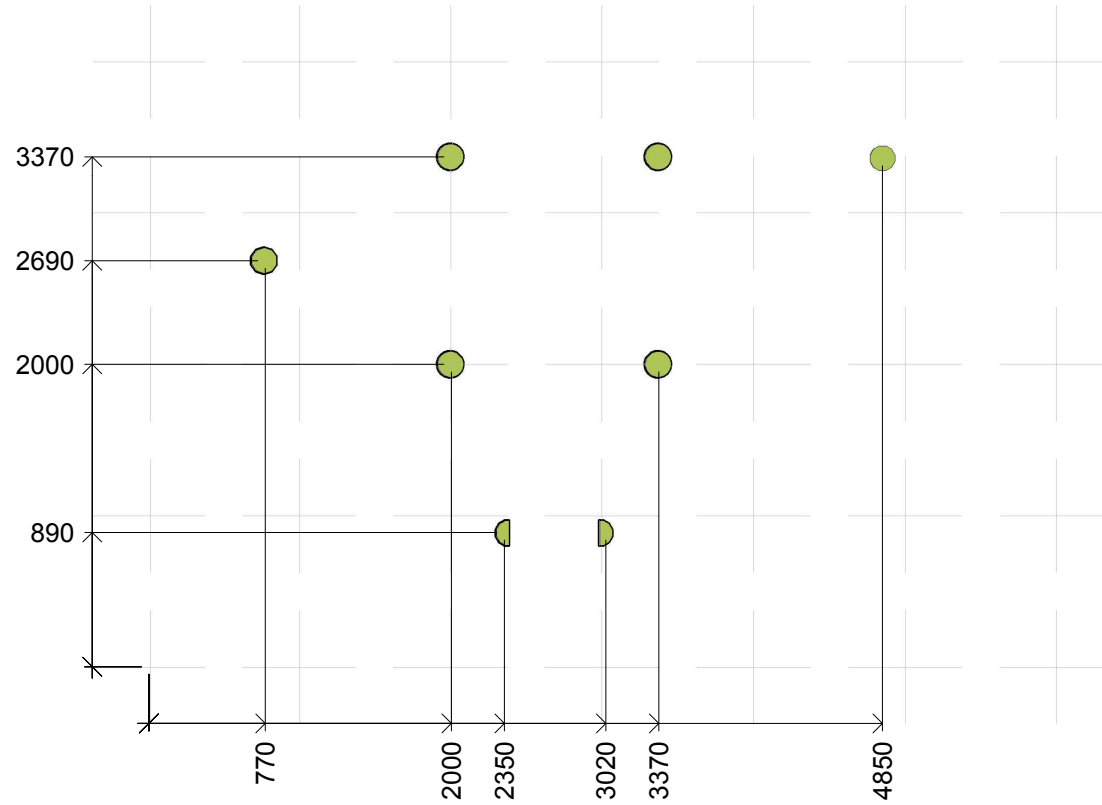
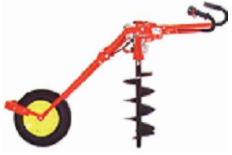

NORLEG	
Klatresystem Brokk	
Z12711	
Dato 22.06.2017	REV. -

< 2500



≥ EN 1176

By assembly. Drilling and use of saw must be expected.

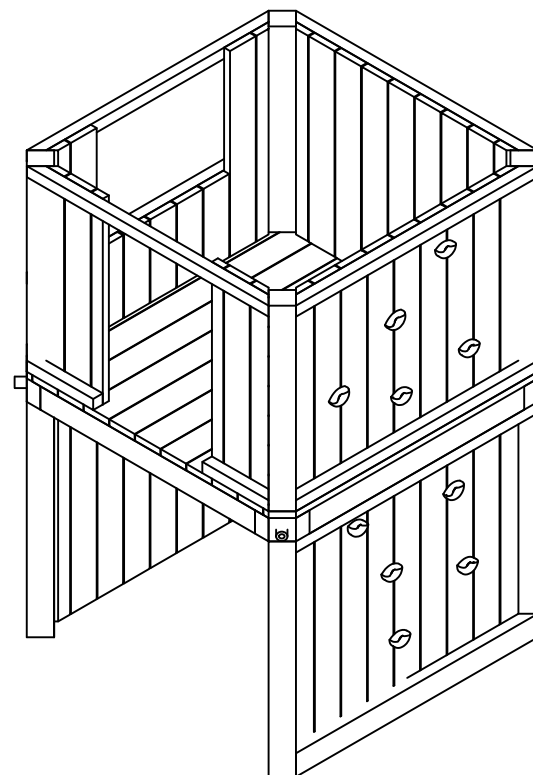
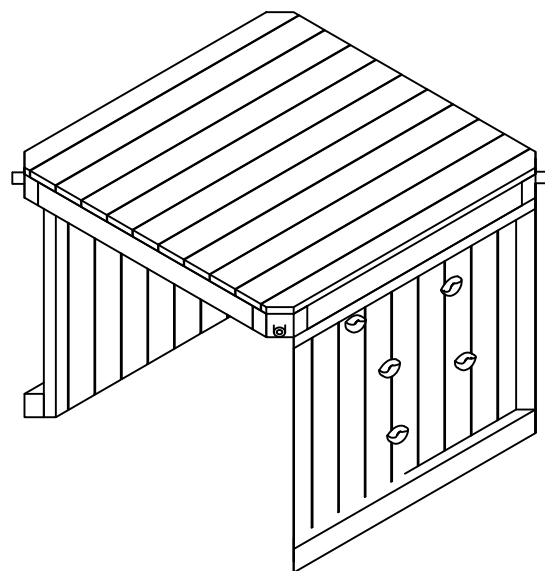

NORLEG	
Klatresystem Brokk	
Z12711	
Dato 22.06.2017	REV. -

< 2500

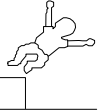

≥ EN 1176

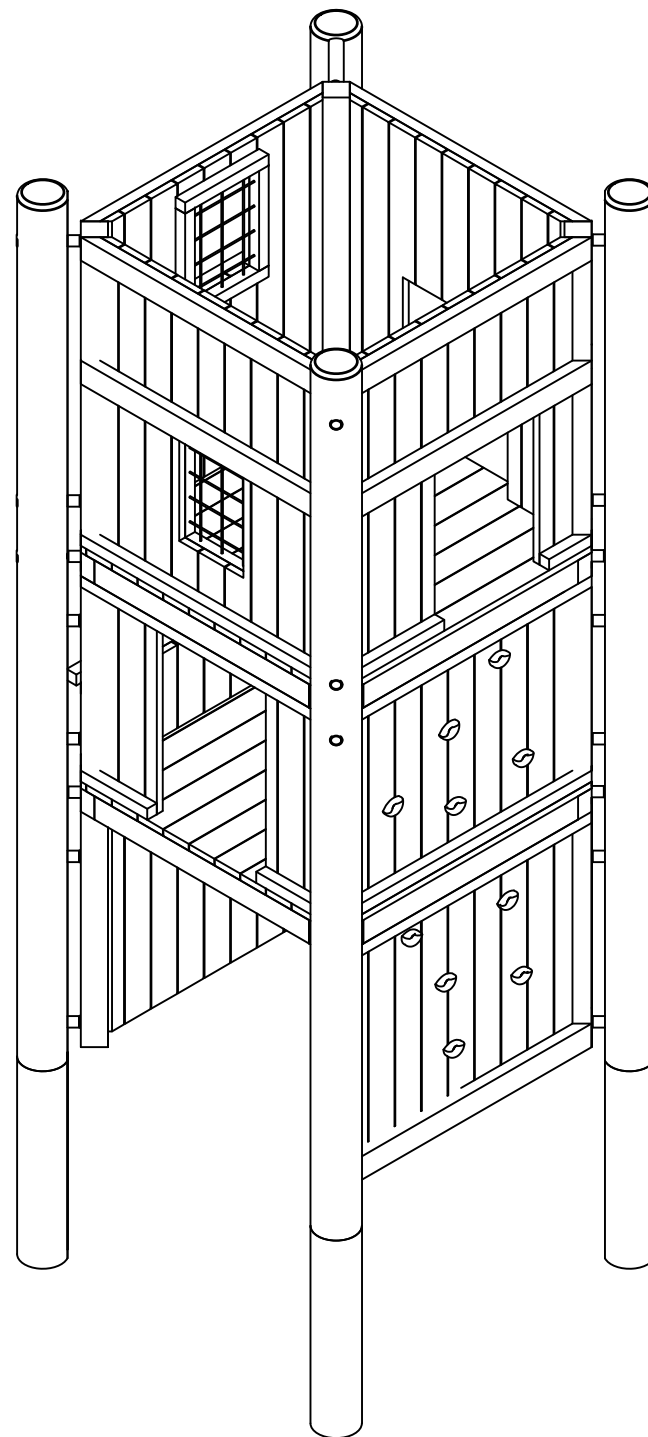
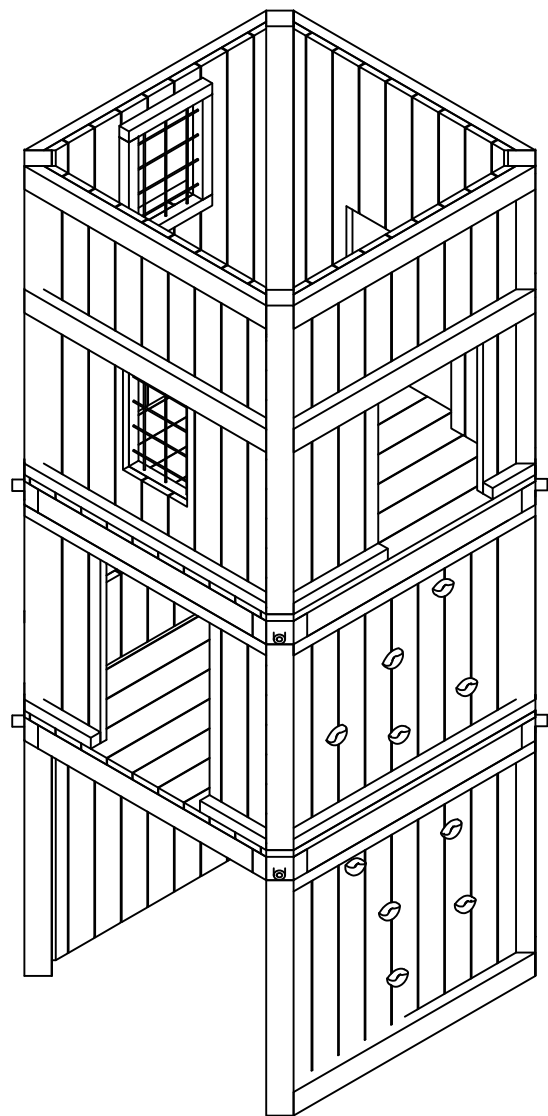

This drawing is the property of NORLEG and pursuant to current legislation may not be copied, transferred to or used by any third party. Should this drawing be used, a fee of 10% of the assumed contract price will be charged.

NORLEG	
Klatresystem Brokk	
Z12711	
Dato 22.06.2017	REV. -

< 2500



≥ EN 1176

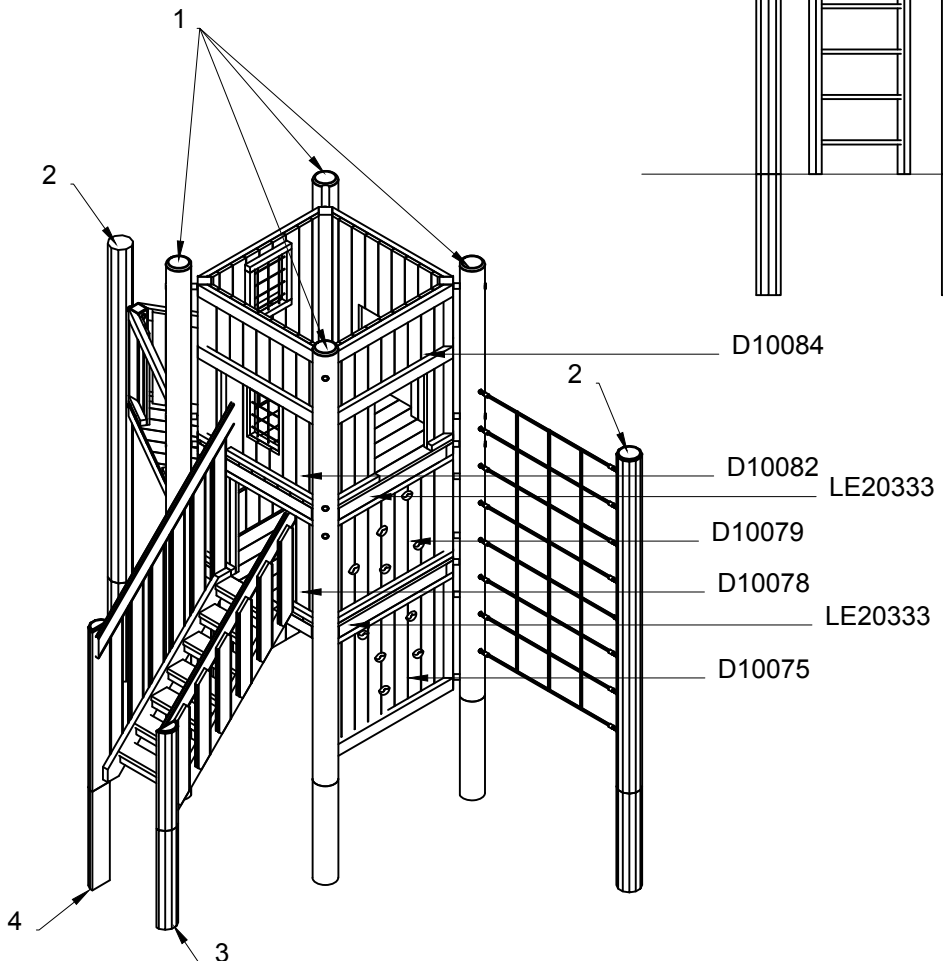

- D10084
- D10082 LE20333
- D10079
- D10078
- LE20333
- D10075

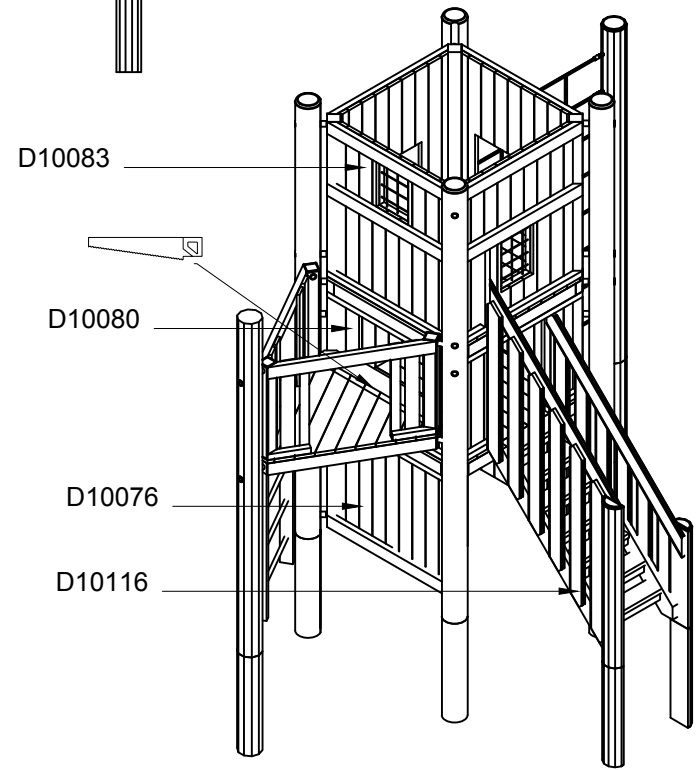

This drawing is the property of NORLEG and pursuant to current legislation may not be copied, transferred to or used by any third party. Should this drawing be used, a fee of 10% of the assumed contract price will be charged.

1:50

NORLEG	
Klatresystem Brokk	
Z12711	
Dato 22.06.2017	REV. -

< 2500



≥ EN 1176

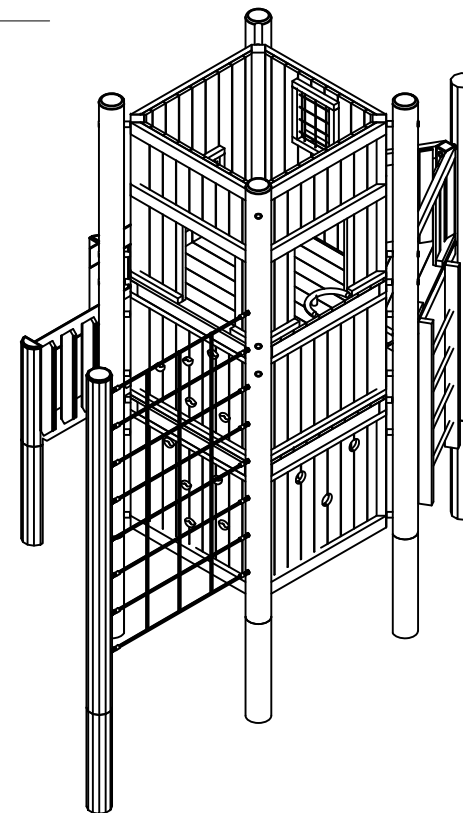
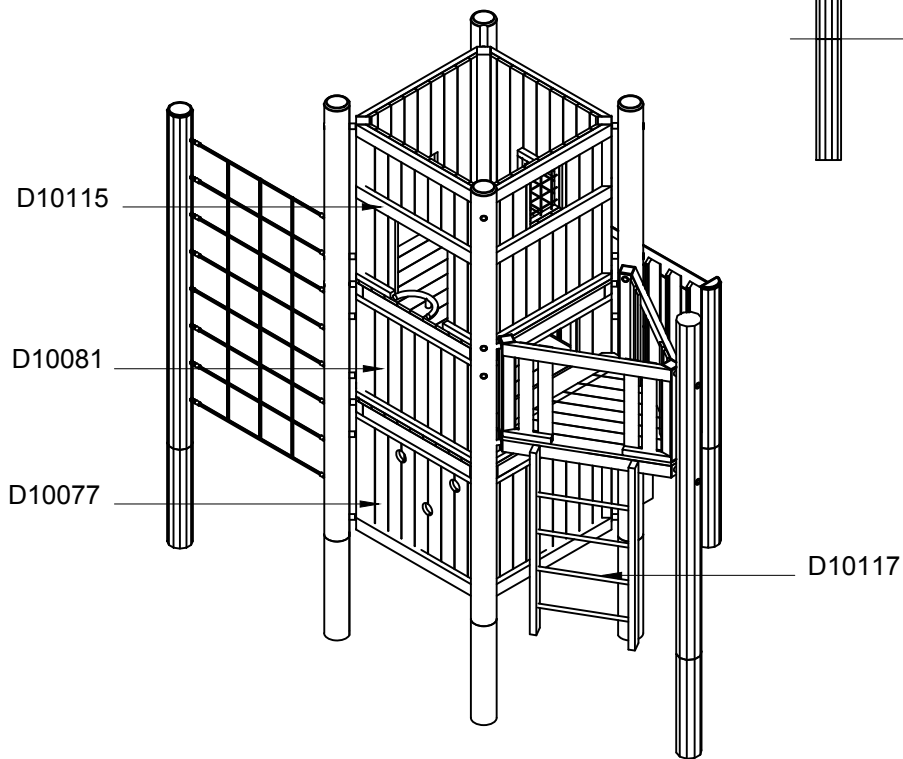
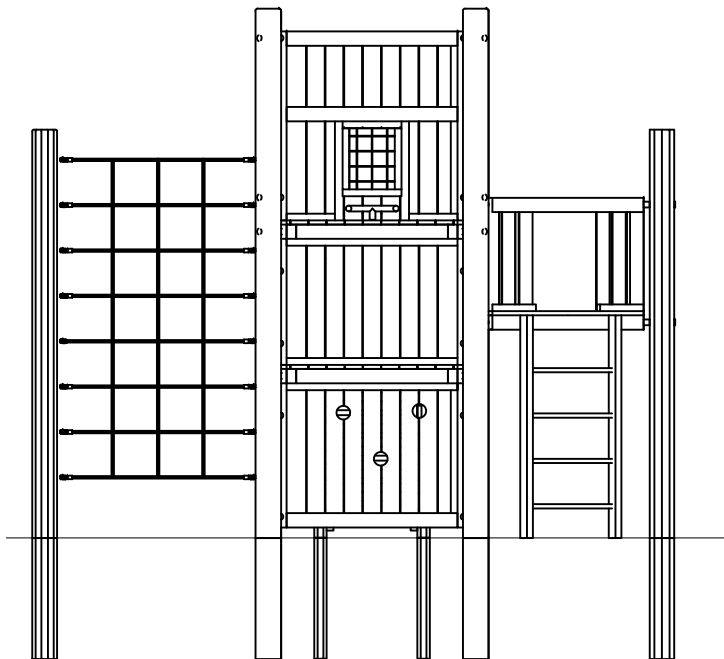

NORLEG	
Klatresystem Brokk	
Z12711	
Dato 22.06.2017	REV. -

< 2500



≥ EN 1176

Mont.p. nr.

- 4
- 19
- 23A
- 27
- 28A
- 52A
- 54A
- 67

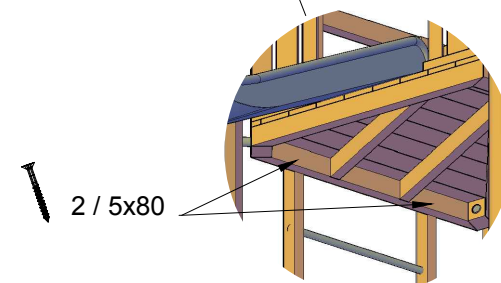
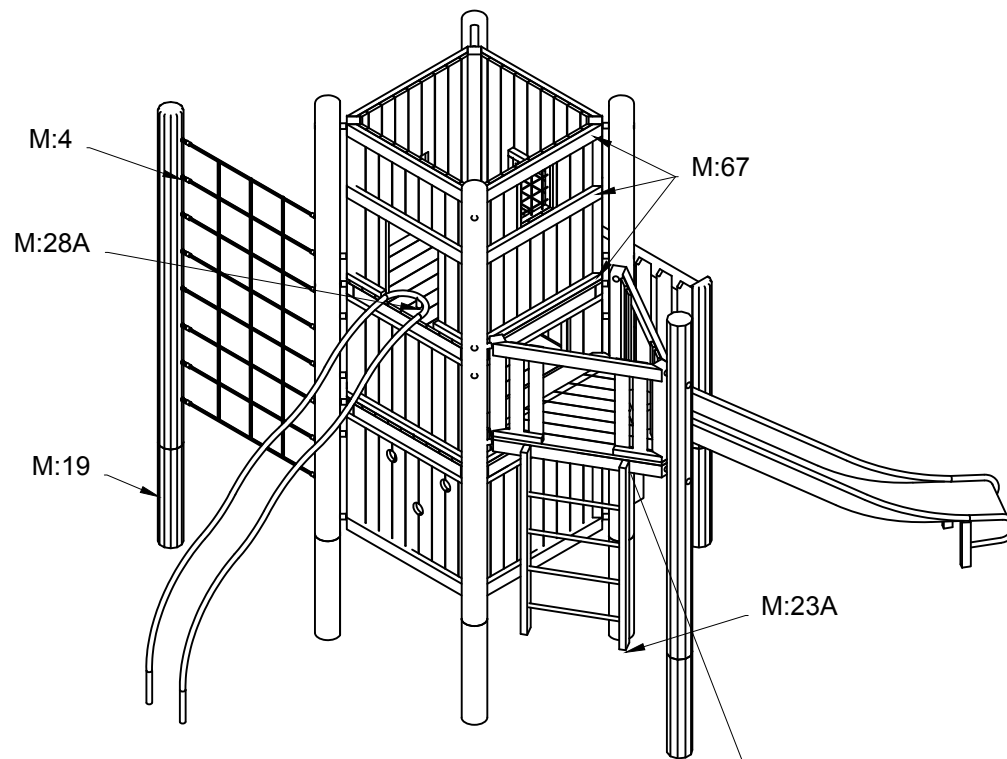
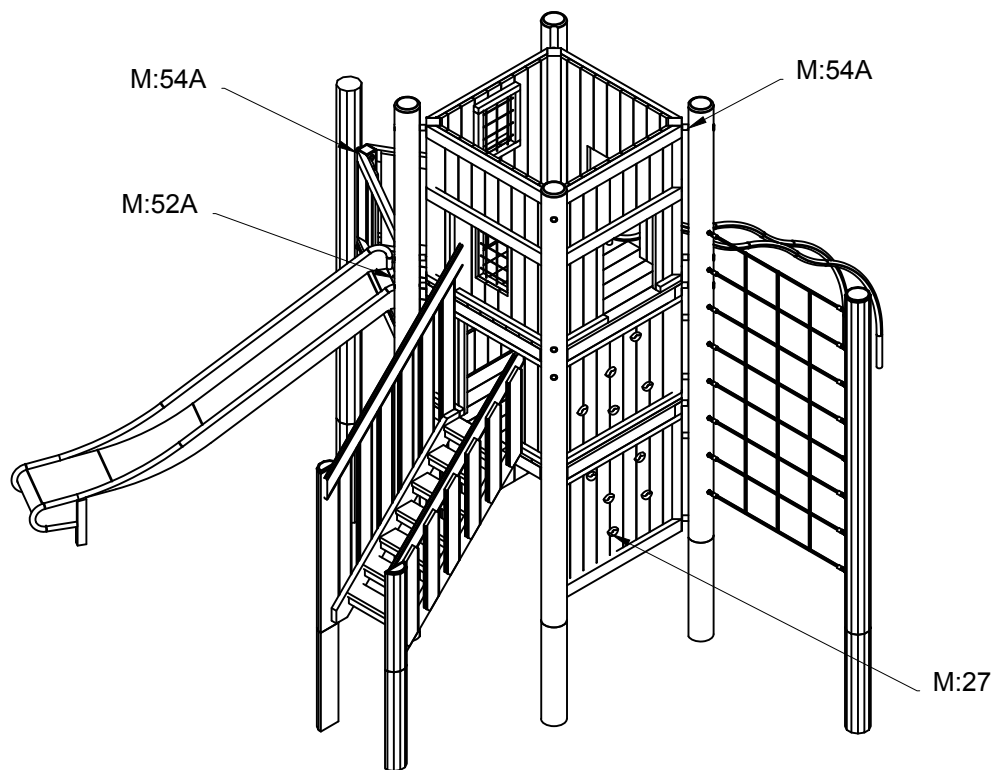

This drawing is the property of NORLEG and pursuant to current legislation may not be copied, transferred to or used by any third party. Should this drawing be used, a fee of 10% of the assumed contract price will be charged.

1:50